

# BAY 1

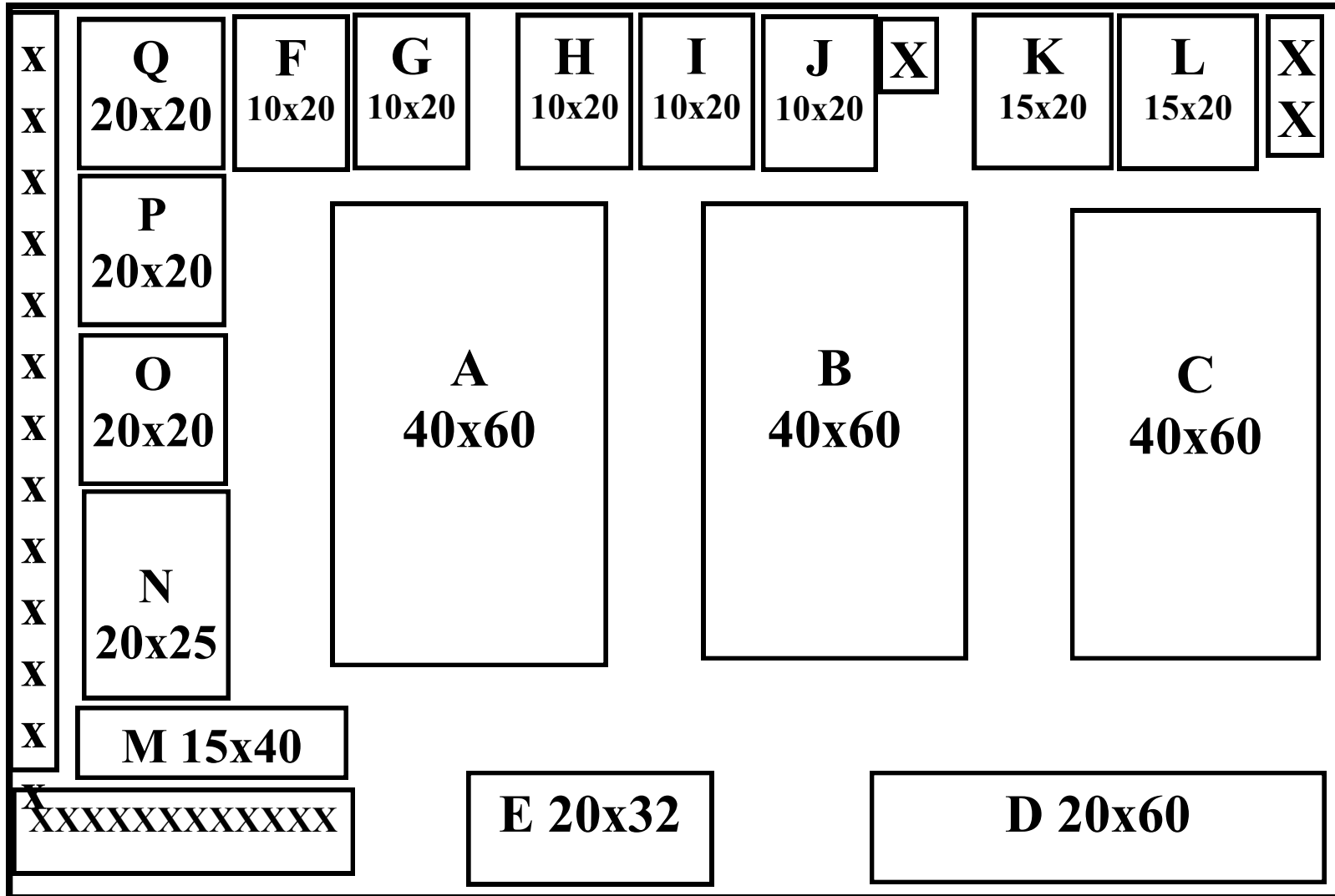

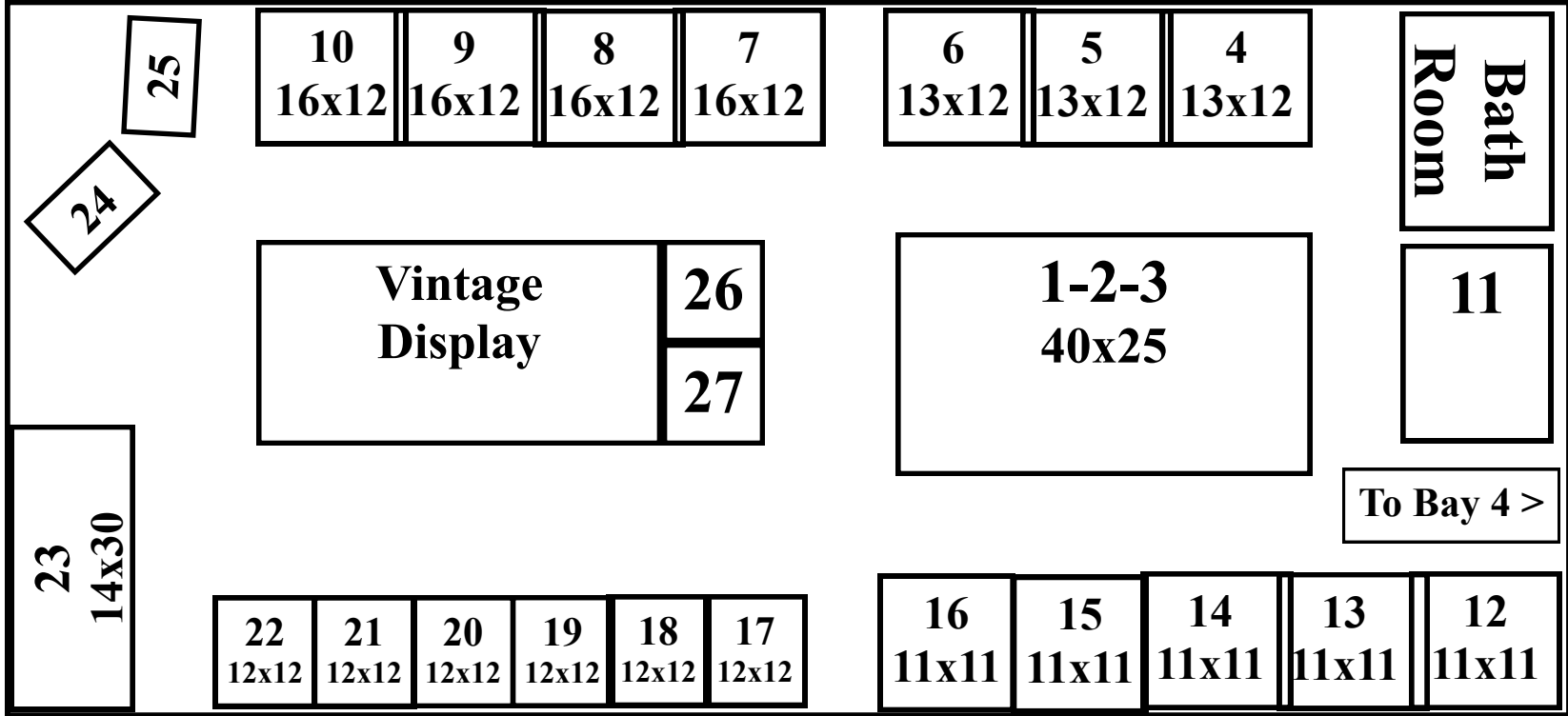

**BAY 2** 





# BAY 3

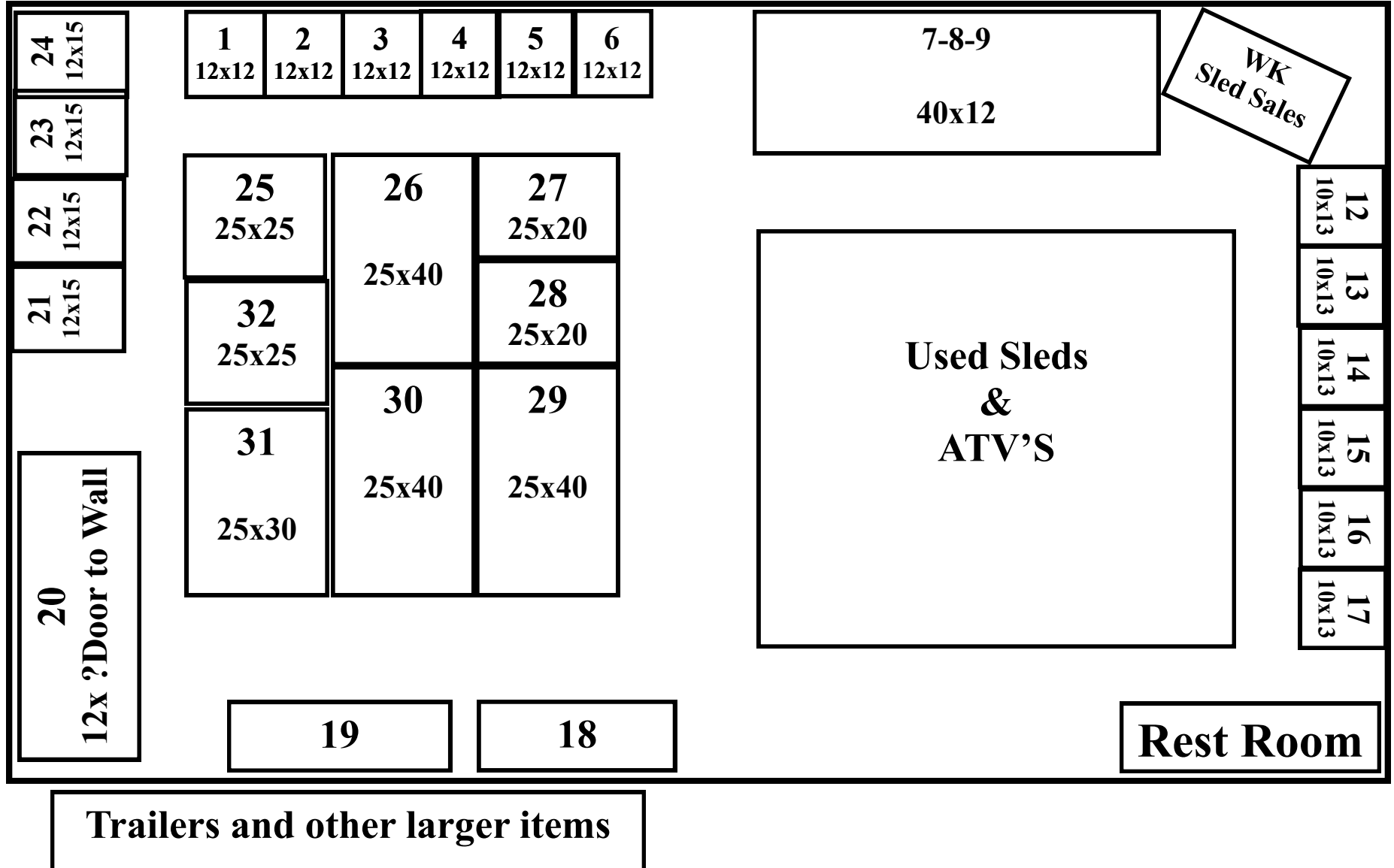

# BAY 4

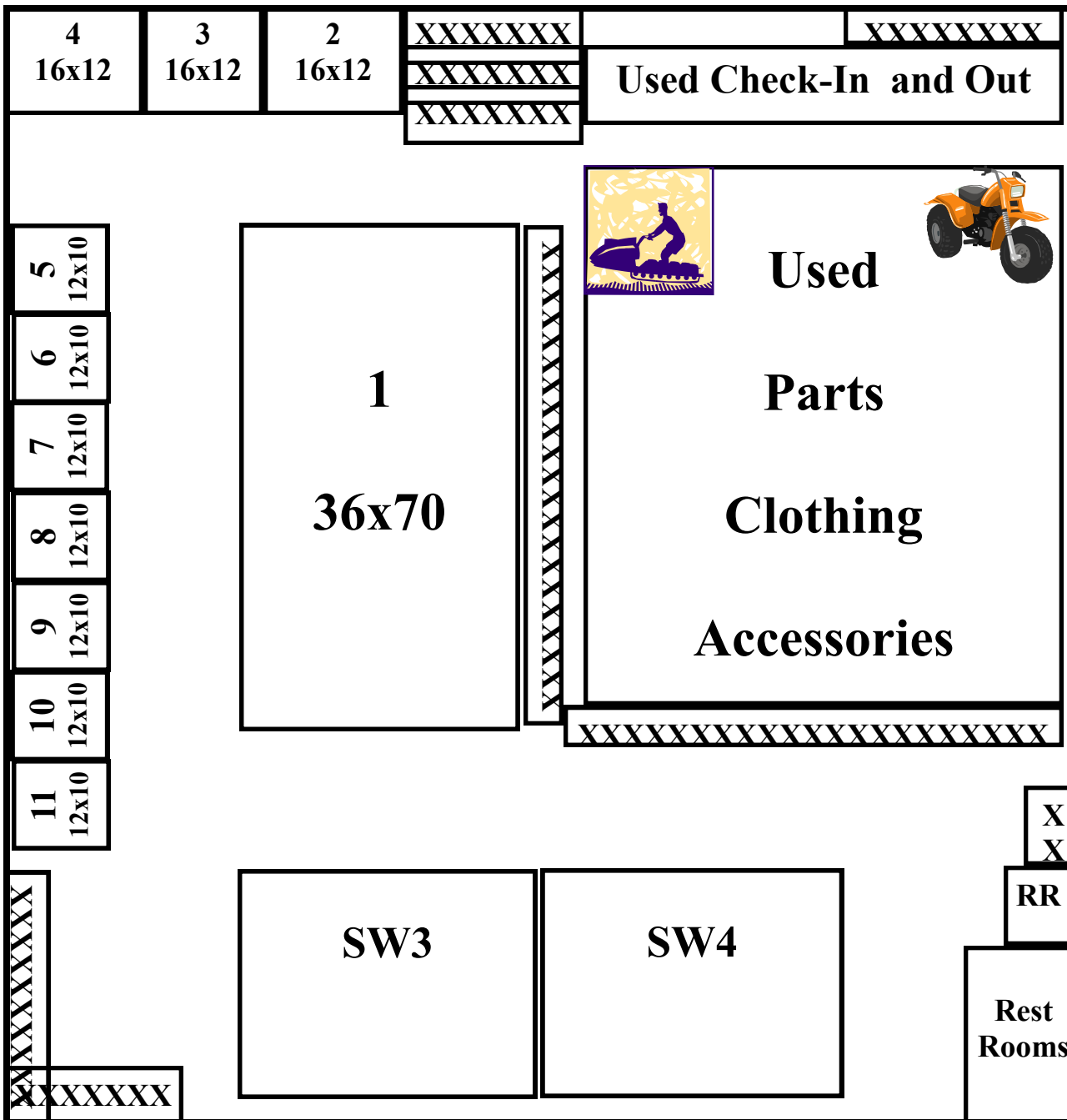



**Exhibitors  
&  
WK Club  
Members  
  
ONLY**

**PLAZA**

**Rest Rooms**

**E  
N  
T  
E  
R**

**1  
WSSA  
Safety Trailer**



**2  
WK  
S.A.R Trailer**

**3  
  
12x32**

**4**

**5**

**6  
WA State  
Parks**

**7  
Winter  
Knights**

**8  
WSSA  
R-Trailer**

**9  
  
16x40**

**10  
  
16x40**

**XXX  
XXX  
XXX  
XXX  
XXX  
XXX  
XXX  
XXX  
XXX  
XXX  
XXX**



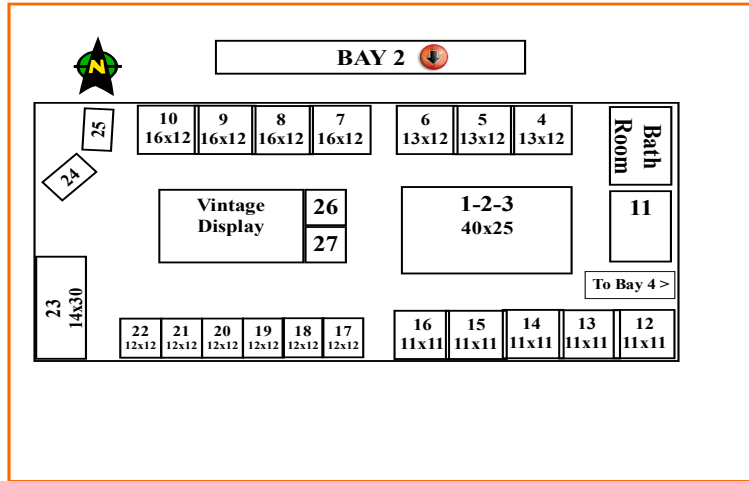
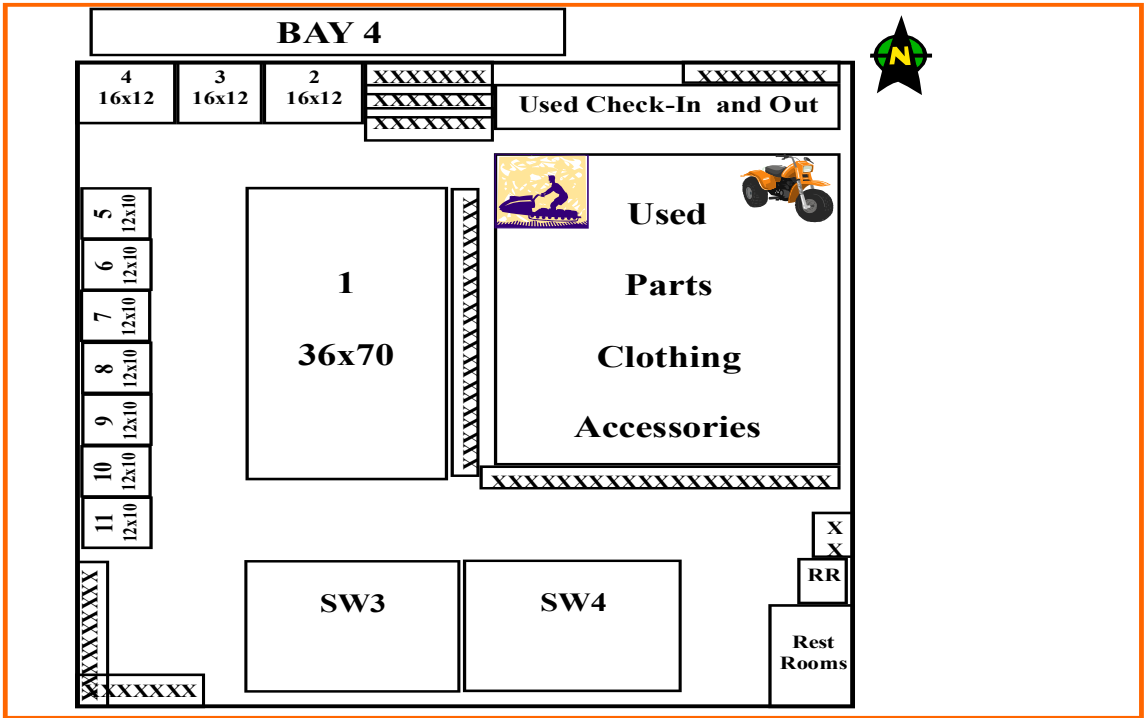
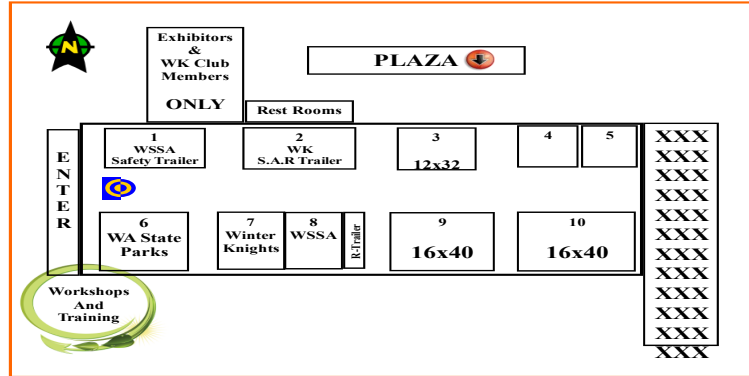
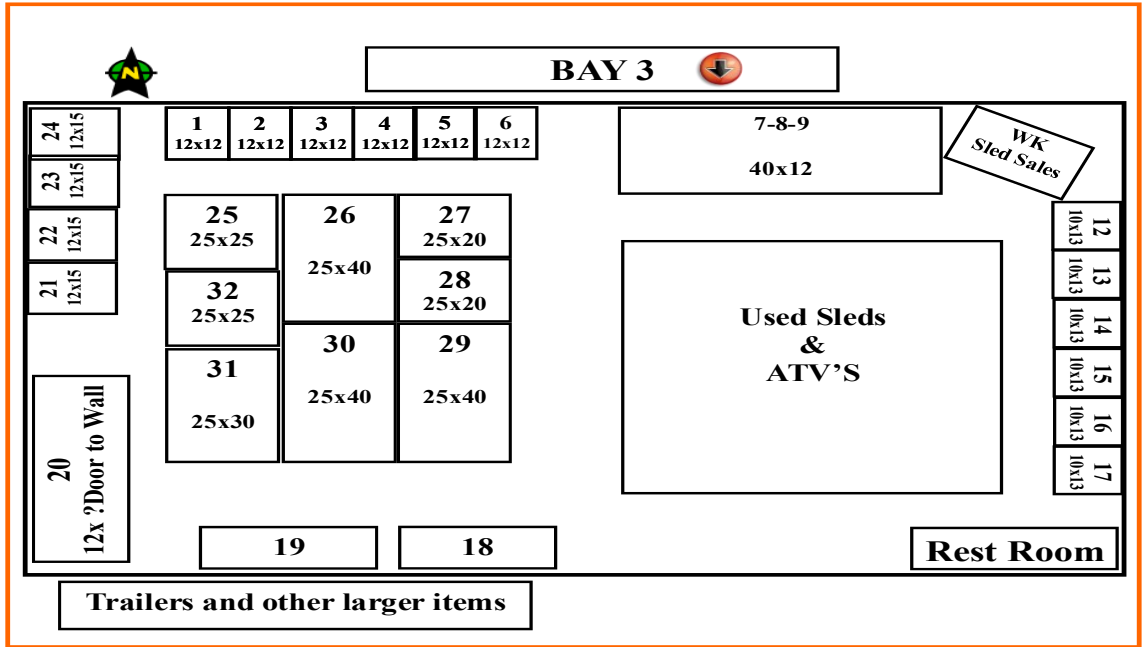
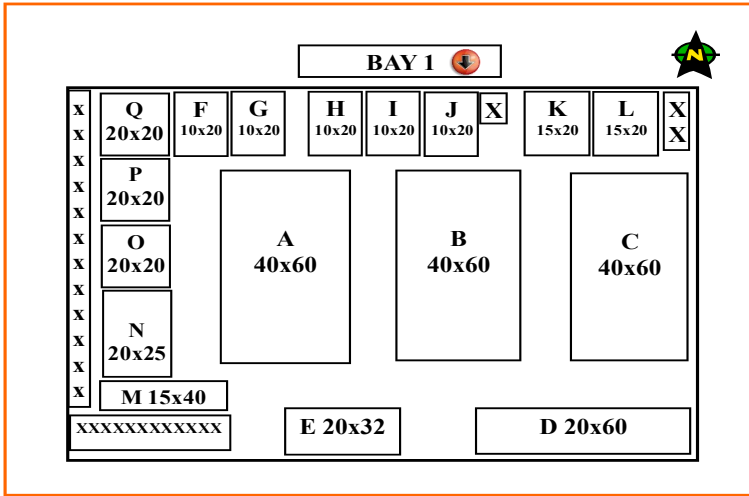



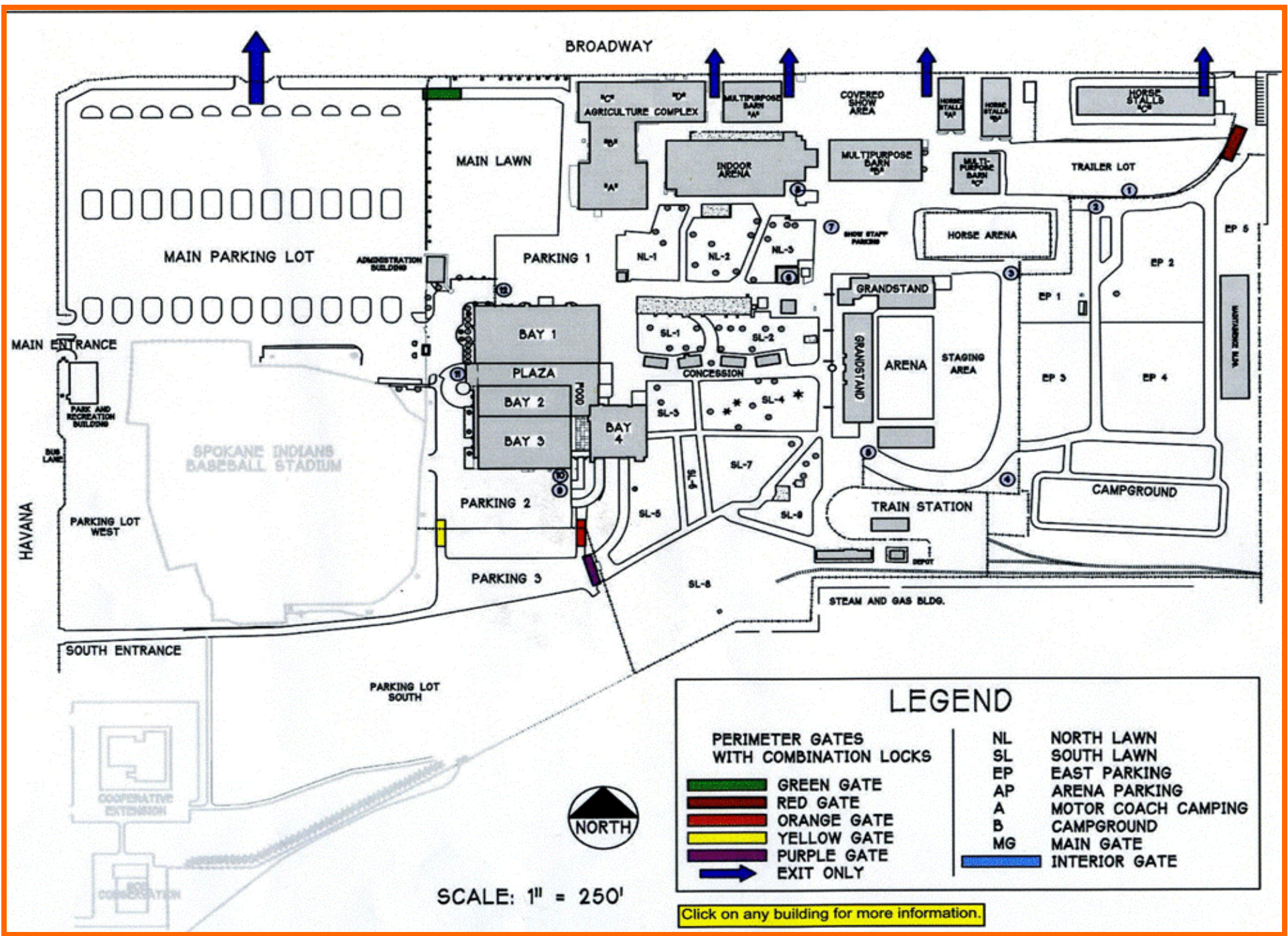

SCALE: 1" = 250'

### LEGEND

PERIMETER GATES WITH COMBINATION LOCKS		NL	NORTH LAWN
	GREEN GATE	SL	SOUTH LAWN
	RED GATE	EP	EAST PARKING
	ORANGE GATE	AP	ARENA PARKING
	YELLOW GATE	A	MOTOR COACH CAMPING
	PURPLE GATE	B	CAMPGROUND
	EXIT ONLY	MG	MAIN GATE
			INTERIOR GATE

Click on any building for more information.



